



**enzie Space Saving Stairs Pty. Ltd.**

287 Arthur Street  
 Fairfield, Victoria  
 Australia, 3078  
 Ph. +61 3 9481 2255  
 Fax +61 3 9481 8919  
 ACN: 126 708 118  
 www.enzie.com.au

Steel landing supplied by **enzie** or timber landing built in as part of stair installation.

**STANDARD SPECIFICATIONS**

**CONSTRUCTION**

The stair is spiral with tapered box-section treads which are made from 2 mm and 1.6 mm mild steel. Column is 4.9 mm thick by 101.2 mm diameter mild steel. The handrail is tubular 19 mm OD by 1.6 mm mild steel and balusters are 16 mm OD by 1.6 mm steel. The stair structure is mechanically jointed on site, requiring no site welding or finishing. The maximum length of any component is slightly more than one metre, and weight is less than 15 kg. The stair can be assembled in a clockwise or an anticlockwise direction. The stair base-plate fits on top of the floor surface before or after floor coverings. The pre-finished stair, when erected, is complete; no further finishing is required by others; no unsightly welds, nuts or bolts are showing.

**SURFACE TREATMENT**

Internal stairs are supplied pre-finished in a high quality baked polyester powder coating. A range of 21 decorator colours is offered for customer selection. The handrail, in addition to finishes above, is available in stainless steel. External stairs are supplied galvanized and primed with zinc rich epoxy before being finished in baked polyester powder-coating.

**INSTALLATION**

Mechanical jointing and factory pre-finishing of the stair allows installation after all other trades, including floor coverings, have been completed in the stairwell and adjoining area. Installation can be carried out by a local contractor or handyman to installation instructions supplied with stair kit. The stair kit includes all nuts, bolts, installation accessories and an installation instructional DVD.

**SAFETY**

An Accreditation Certificate issued under B.C.A. endorses the safety elements of the system. The synthetic rubber anti-skid pad, applied to the top of stair treads ensures safe access. Handrail balusters on the staircase are spaced as standard at a maximum of 180 mm, and on the balcony balustrade are spaced at a maximum of 125 mm. Optional extra gate can be supplied for the top or the bottom of the staircase.

**DETAILS OF enzie 1880m DIAMETER SPIRAL STAIR GEOMETRY OF STAIRS**

Stair is made with risers between 178 and 190 mm 16 steps to circle at 22.5 degrees. The going measured at 7/10 ths. of the clear width is 224 mm and slope relationship is between 586 to 606

**TREADS AND RISES**

Treads are uniform shape and size. Risers are of uniform height between 178 mm and 190 mm as required by client's application. Anti-skid pad for each tread is supplied. This pad is replaceable if wear should occur.

**HEAD ROOM**

Using standard 90 degree landing 120 mm thick with 180 mm riser clear headroom is 2030 mm. Every 1 mm added to riser adds 12 mm to headroom.

**HANDRAIL**

Continuous and uninterrupted handrail is provided on one side and is at a vertical height of 866 mm minimum above the nosing of the tread. Balcony railing is 1000 mm above the floor.

**WIDTH**

The width of stair free of obstruction is 810mm.

**BUILDING APPROVALS**

Procedure for building approval is to include a copy of this Data Sheet and Accreditation Certificate for the system with drawings showing location of proposed installation (with your required documentation) to the local building authority for their approval. Computations available on request for submission to Building Authority.

**PACKED WEIGHT**

Approximately 17 kg per riser.

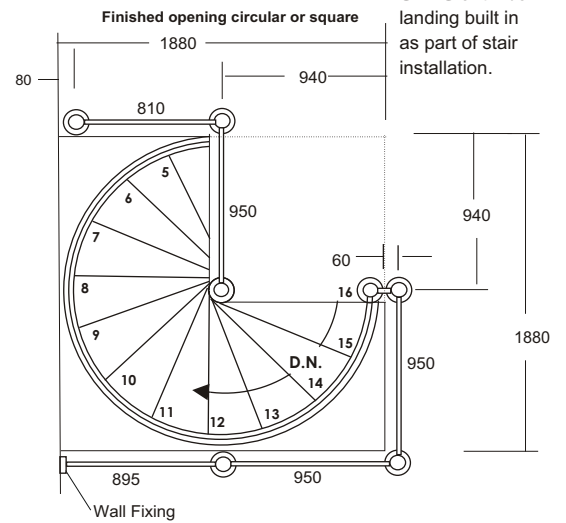

Standard stairwell and Balcony rails

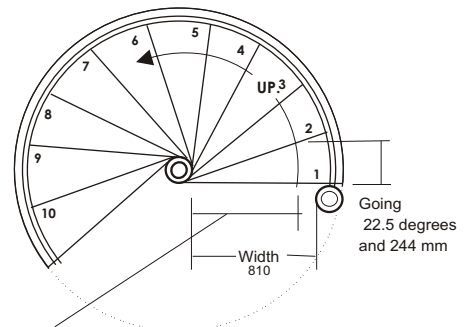
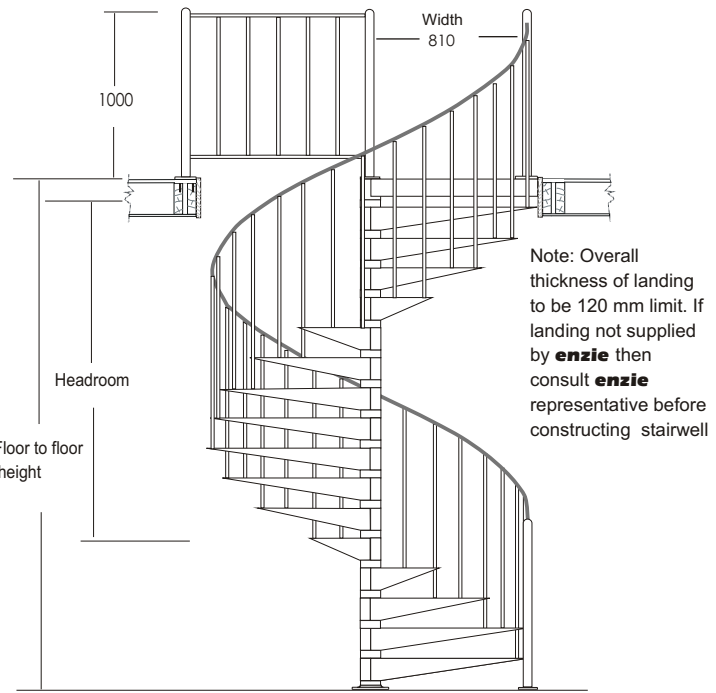

Measurement line for slope relationship is between 604 and 624 measured at 7/10 of the unobstructed stair width

## FIXING DETAILS

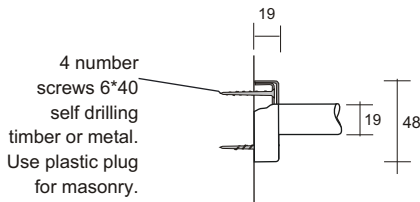
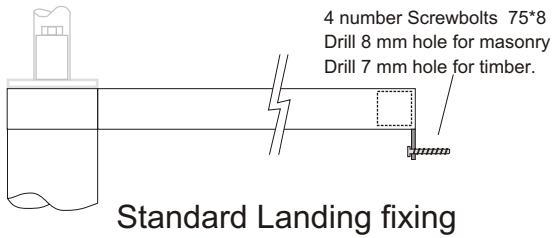

Wall fixing

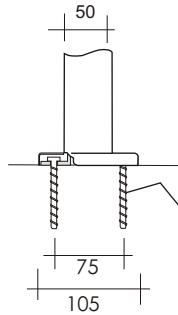

Handrail post base

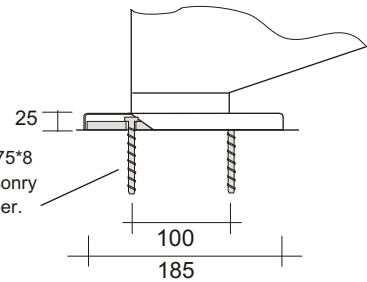

Base Plate

## SETTING OUT EXAMPLES

1880 Diameter 178 mm to 190 mm Riser 16 Treads to circle at 22.5 Degrees

Floor to Floor Height (up to)	2280	2470	2660	2850	3040	3230	3420	3610	3800	3990	4180
<b>Number of risers</b>	12	13	14	15	16	17	18	19	20	21	22
<b>Number of treads</b>	11	12	13	14	15	16	17	18	19	20	21
<b>Going</b>	247	270	292	315	337	360	382	405	427	450	472
<b>16 Treads to circle at 22.5 Degrees</b>											

Some typical top landing examples

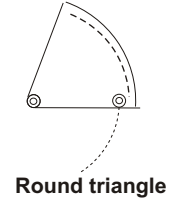
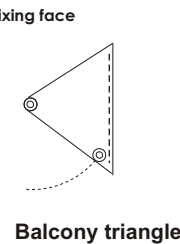
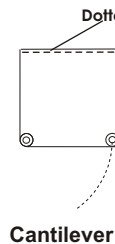
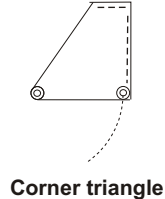
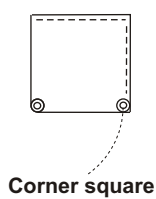

Dotted line denotes fixing face

## FINISHES



Powder-Coated

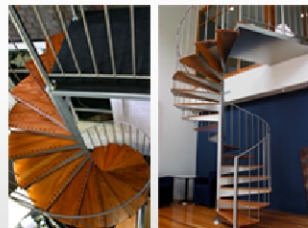

Timber-Overlays



Stainless Steel



Aluminium Enfold

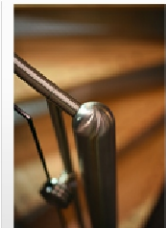

Glass enfold



- 22 Standard Colours
- 6 Metallic Colours
- Non-slip tread-pads

- Your Choice of Hard Woods
- Clear Polyurethane Finish
- Non-slip Nosing

- 304 or 316

- Opt. Anodizing

- 6mm Toughened Glass

# DATA SHEET enzie H 1880/16 SPIRAL STAIR